

KENWOOD

INSTRUCTION MANUAL MANUAL DE INSTRUCCIONES



VHF APCO P25 TRANSCEIVER
TRANSCPTOR APCO P25 VHF

TK-5210

KENWOOD CORPORATION

© B62-1796-10 (K)
09 08 07 06 05 04 03 02 01

THANK YOU

We are grateful you chose **KENWOOD** for your land mobile radio applications. We believe this easy-to-use transceiver will provide dependable communications to keep personnel operating at peak efficiency.

KENWOOD transceivers incorporate the latest in advanced technology. As a result, we feel strongly that you will be pleased with the quality and features of this product.

NOTICES TO THE USER

- ◆ GOVERNMENT LAW PROHIBITS THE OPERATION OF UNLICENSED RADIO TRANSMITTERS WITHIN THE TERRITORIES UNDER GOVERNMENT CONTROL.
- ◆ ILLEGAL OPERATION IS PUNISHABLE BY FINE OR IMPRISONMENT OR BOTH.
- ◆ REFER SERVICE TO QUALIFIED TECHNICIANS ONLY.

SAFETY: It is important that the operator is aware of and understands hazards common to the operation of any transceiver.

WARNING:

EXPLOSIVE ATMOSPHERES (GASES, DUST, FUMES, etc.)

Turn off your transceiver while taking on fuel, or while parked in gasoline service stations.

This device made under license under one or more of the following US Patents: 4,590,473; 4,636,791; 4,716,407; 4,972,460; 5,148,482; 5,185,796; 5,271,017; 5,377,229; 5,502,767.

The IMBE™ voice coding Technology embodied in this product is protected by intellectual property rights including patent rights, copyrights, and trade secrets of Digital Voice Systems, Inc. This voice coding Technology is licensed solely for use within this Communications Equipment. The user of this Technology is explicitly prohibited from attempting to decompile, reverse engineer, or disassemble the Object Code, or in any other way convert the Object Code into a human-readable form.

One or more of the following statements may be applicable:

FCC WARNING

This equipment generates or uses radio frequency energy. Changes or modifications to this equipment may cause harmful interference unless the modifications are expressly approved in the instruction manual. The user could lose the authority to operate this equipment if an unauthorized change or modification is made.

INFORMATION TO THE DIGITAL DEVICE USER REQUIRED BY THE FCC

This equipment has been tested and found to comply with the limits for a Class B digital device, pursuant to Part 15 of the FCC Rules. These limits are designed to provide reasonable protection against harmful interference in a residential installation.

This equipment generates, uses and can generate radio frequency energy and, if not installed and used in accordance with the instructions, may cause harmful interference to radio communications. However, there is no guarantee that the interference will not occur in a particular installation. If this equipment does cause harmful interference to radio or television reception, which can be determined by turning the equipment off and on, the user is encouraged to try to correct the interference by one or more of the following measures:

- Reorient or relocate the receiving antenna.
- Increase the separation between the equipment and receiver.
- Connect the equipment to an outlet on a circuit different from that to which the receiver is connected.
- Consult the dealer for technical assistance.



ATTENTION (U.S.A. Only):

The RBRC Recycle seal found on **KENWOOD** nickel-cadmium (Ni-Cd) battery packs indicates **KENWOOD's** voluntary participation in an industry program to collect and recycle Ni-Cd batteries after their operating life has expired. The RBRC program is an alternative to disposing Ni-Cd batteries with your regular refuse or in municipal waste streams, which is illegal in some areas.

For information on Ni-Cd battery recycling in your area, call (toll free) 1-800-8-BATTERY (1-800-822-8837).

KENWOOD's involvement in this program is part of our commitment to preserve our environment and conserve our natural resources.

UNPACKING AND CHECKING EQUIPMENT

Note: The following unpacking instructions are for use by your

KENWOOD dealer, an authorized **KENWOOD** service facility, or the factory.

Carefully unpack the transceiver. We recommend that you identify the items listed in the following table before discarding the packing material. If any items are missing or have been damaged during shipment, file a claim with the carrier immediately.

SUPPLIED ACCESSORIES

Item	Parts Number	
Instruction Manual	B62-1796-00	1
Pamphlet	B59-2390-00	1
Belt Hook	J29-0710-05	1
Screw Set	N99-2044-05	1
Cap	B09-0682-03	1

Appearance

TOP

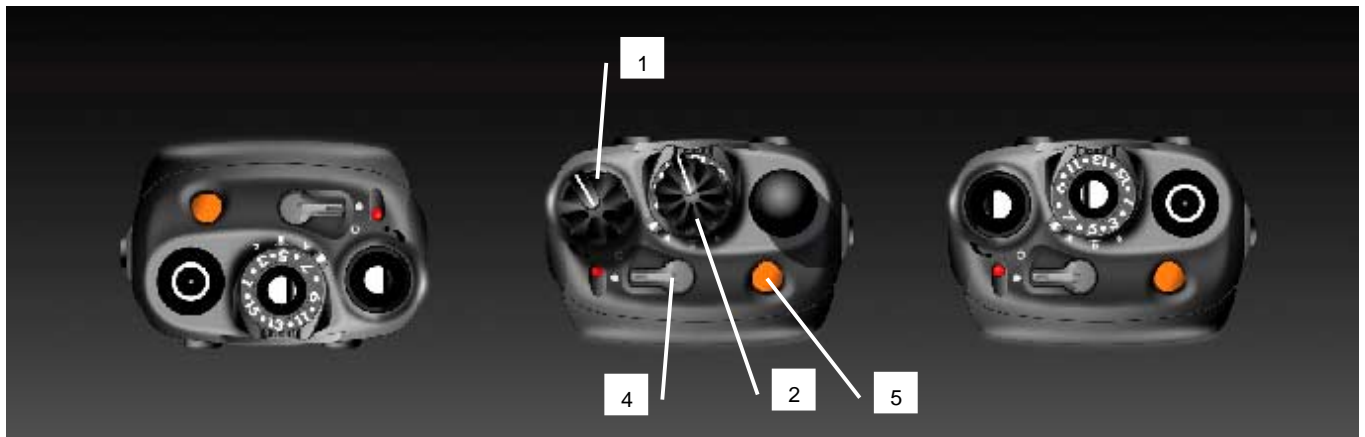

No.	Name	Correspondence	Note
1	Power SW/Volume control	Type 1/2/3	
2	Selector	Type 1/2/3	
3	Concentric Switch	Type 1/2/3	
4	Lever Switch	Type 1/2/3	
5	Orange key	Type 1/2/3	

Front



No.	Name	Correspondence	Note
1	PF A key	Type 2/3	
2	PF B key	Type 2/3	
3	PF C key	Type 2/3	
4	PF D key	Type 2/3	
5	12 keypad	Type 3	

Side



No.	Name	Correspondence	Note
1	Side1 key	Type 1/2/3	
2	PTT	Type 1/2/3	
3	Side2 key	Type 1/2/3	
4	Side3 key	Type 1/2/3	

Key

	Type1	Type2	Type3
(Power SW/Volume)	Power Switch/Volume	Power Switch/Volume	Power Switch/ Volume
(Selector)	16 Position Rotaly SW	16 Position Rotaly SW	16 Position Rotaly SW
(Concentric Switch)	3 Position Selector	3 Position Selector	3 Position Selector
(Lever Switch)	2 Position Selector	2 Position Selector	2 Position Selector
(Orange)	Orange	Orange	Orange
(Side 1)	Side 1	Side 1	Side 1
(Side 2)	Side 2	Side 2	Side 2
(Side 3)	Side 3	Side 3	Side 3
(PTT)	PTT	PTT	PTT
(A)	--	A	A
(B)	--	B	B
(C)	--	C	C
(D)	--	D	D
(DTMF 12 Key)	--	--	DTMF

1.1 LCD(Type2,Type3)

Standard Display (2Line)

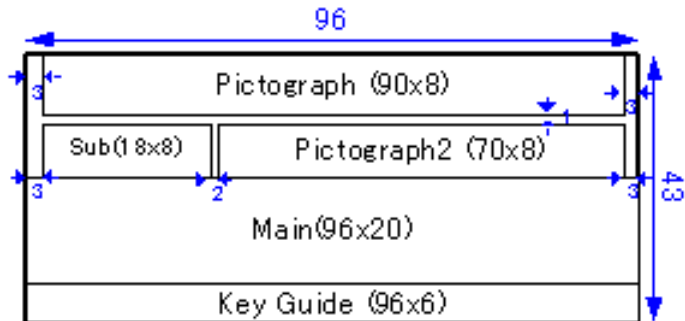

Message Display (3Line)

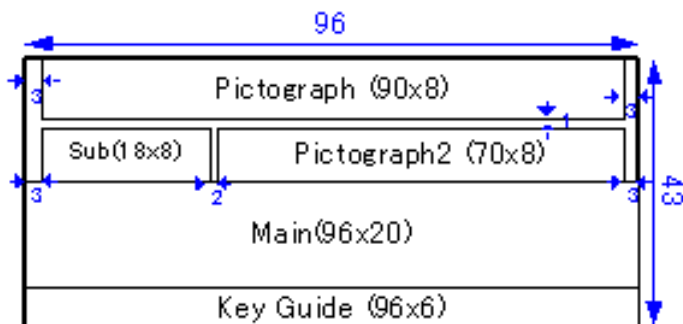













Conventional



Trunking



1.2 Icon

	Function
	RSSI (at Trunking)
	Priority Channel P1 :Priority 1 Channel P2 :Priority 2 Channel PP :Priority 1&2 Channel
	Monitor Open  :Signalling Off, Squelch Off
	Scan  :Scan, Scan stop
	Telephone ID (at Telephone Interconnect)
	Message Stack (FleetSync)
	Talk Around
	Option Board (Encryption(Scrambler)=ON)
	RF Power Low
-	Zone Add
	Chennel Add

Universal connector specification

Pin No.	Name	I/O	Analog/ Digital	Function	Specification
1	SSW	I	D	Ext/Int Speaker Switch input	L:External Speaker ON H:Internal Speaker ON
2	SP+	O	A	BTL Output + for External Speaker	Audio Output Power
3	SP-	O	A	BTL Output - for External Speaker	
4	MSW	I	D	Ext/Int MIC Switch Input	L:External Mic ON H:Internal Mic ON
5	EMC	I		External MIC Input	Impedance:1.8kohm typ (at 1kHz)
6	ME			External MIC GND	-
7	PTT	I	D	External PTT Input	L:PTT ON
8	PF	I	A	Programmable Function Key input	1.(KMC-25) is connected 2.(KVL-3000) is connected
9	OPT	I/O		Aux I/O port (for External Option)	1(Man Down Input) 2(Serial Data Input) 3(AUX I/O)
10	E			GND	-
11	5M			5V	5V Power Supply Output
12	TXD	O	D	Serial Data Output	Baud rate:115200bps max
13	RXD	I	D	Serial Data Input	Baud rate:115200bps max
14	NC(E)			Not use (GND)	-

PREPARATION

INSTALLING/ REMOVING THE (OPTIONAL) BATTERY PACK

CAUTION:

- DO NOT RECHARGE THE BATTERY PACK IF IT IS ALREADY FULLY CHARGED. DOING SO MAY CAUSE THE LIFE OF THE BATTERY PACK TO SHORTEN OR THE BATTERY PACK MAY BE DAMAGED.
- AFTER RECHARGING THE BATTERY PACK, DISCONNECT IT FROM THE CHARGER. IF THE CHARGER POWER IS RESET (TURNED ON AFTER BEING TURNED OFF), RECHARGING WILL START AGAIN AND THE BATTERY PACK WILL BECOME OVERCHARGED.
- DO NOT SHORT THE BATTERY TERMINALS OR DISPOSE OF THE BATTERY BY FIRE.
- NEVER ATTEMPT TO REMOVE THE CASING FROM THE BATTERY PACK.

- 1 Match the four grooves of the battery pack with the corresponding guides on the back of the transceiver.
- 2 Slide the battery pack along the back of the transceiver until the release latch on the base of the transceiver locks.

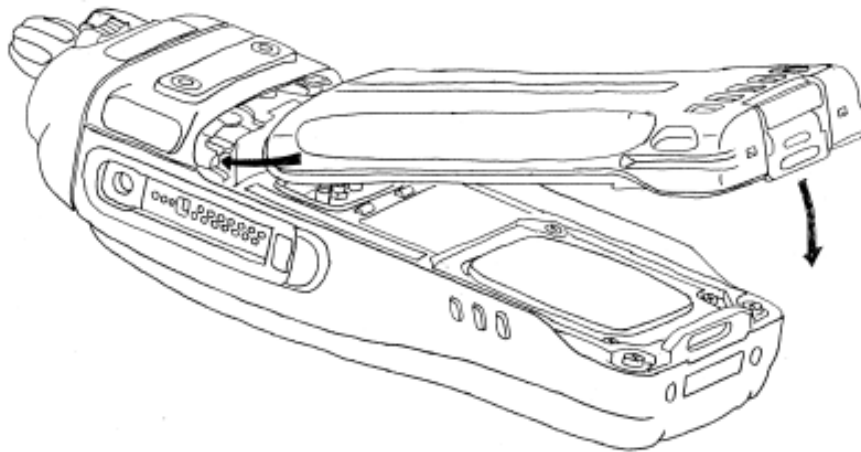

- 3 To remove the battery pack, pull back on the release latch and slide the pack away from the transceiver.

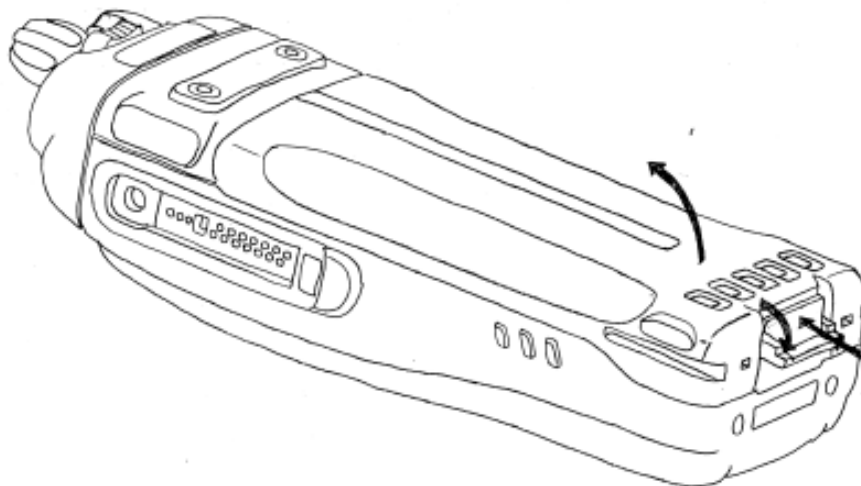

THE ANTENNA INSTALLING

Screw the antenna into the connector on the top of the transceiver by holding the antenna at its base and turning it clockwise until secure.

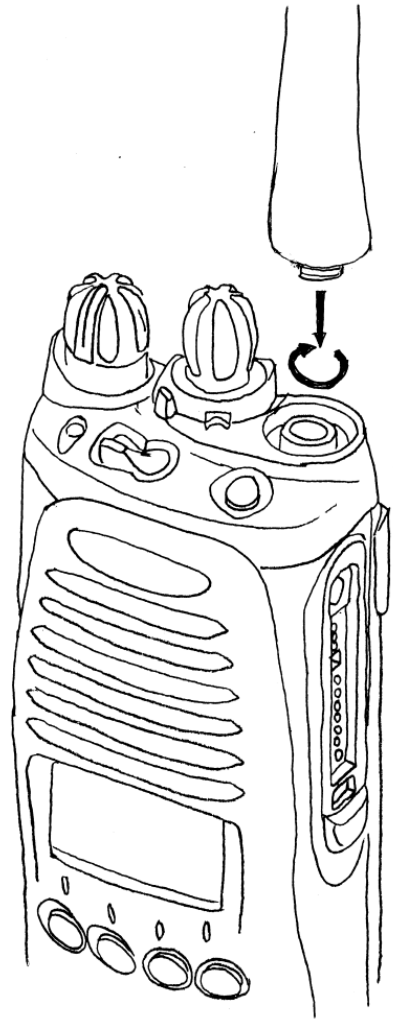

INSTALLING THE BELT CLIP

If necessary, attach the belt clip using the two supplied binding screws.

Note: If the belt clip is not installed, its mounting location may get hot during continuous transmission or when left sitting in a hot environment.

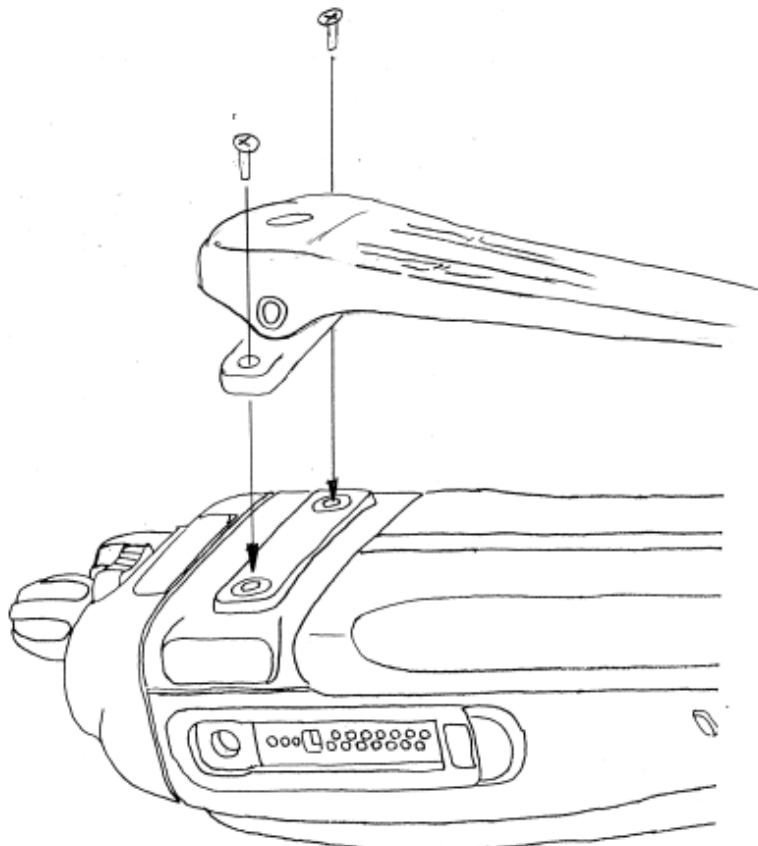

INSTALLING THE COVER OVER THE UNIVERSAL CONNECTOR

If you are not using the optional KMC-** speaker/ microphone, install the cover over the universal connector using the supplied 4 x 6 mm dressing screw.

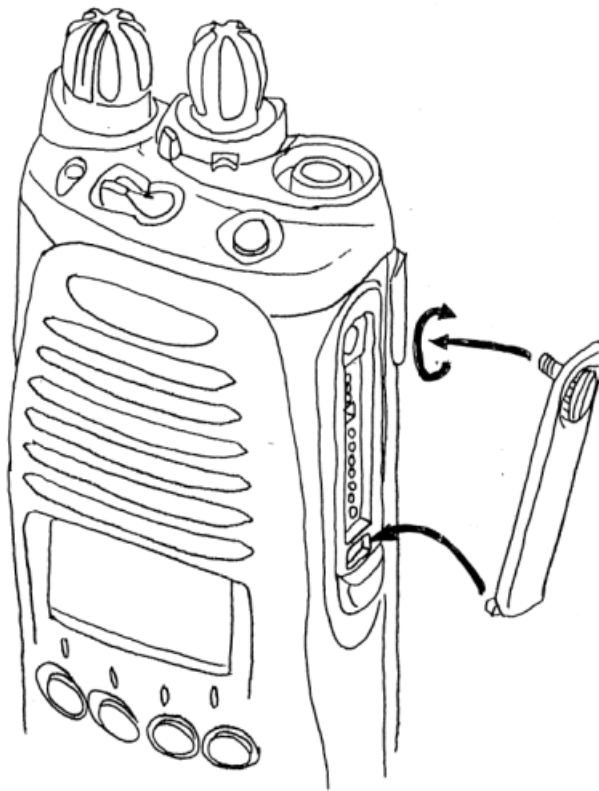

INSTALLING THE (OPTIONAL KMC-25, KMC-25W) SPEAKER/ MICROPHONE

- 1 Insert the guide of the speaker/ microphone connector into the groove of the universal connector.
- 2 Secure the connector in place using the attached screw.

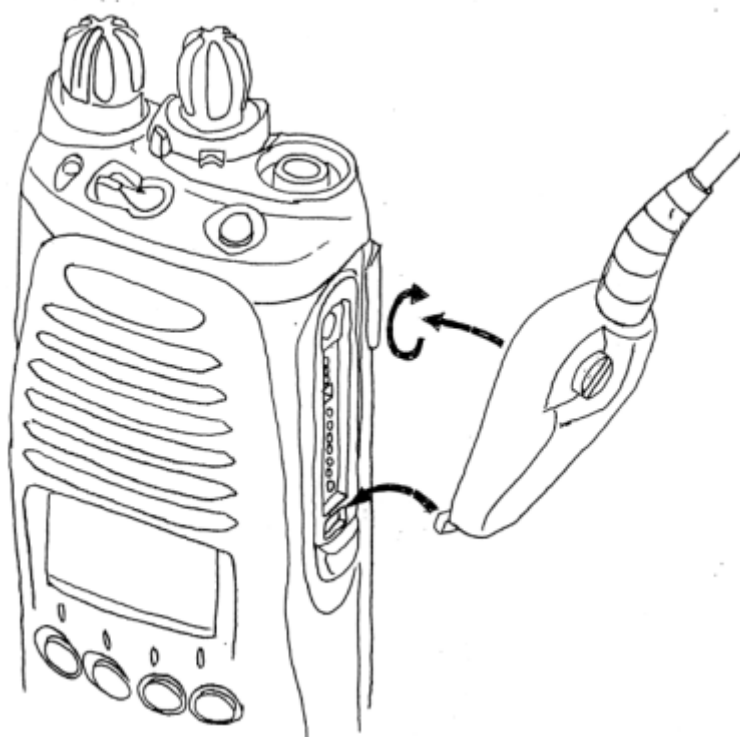

BASIC OPERATIONS

SWITCHING POWER ON/ OFF

Turn the Power switch/ Volume control clockwise to switch the transceiver ON.

If the transceiver is password protected, "PASSWRD" will appear on the display when the power is turned ON.

To unlock the transceiver, enter the correct password:

1 Enter a character using the Side2 and Side3 keys.

If the transceiver is equipped with a 12keypad, you can also enter the password by pressing the appropriate 12keypad keys.

2 Press the D key to accept the character.

This step is unnecessary when using the keypad.

3 Repeat steps 1 and 2 to enter the entire password.

Press the B key to erase an incorrectly entered character.

If you enter an incorrect password, an error tone sounds and the transceiver remains locked.

The password can contain a maximum of 6 digits.

Turn the Power switch/ Volume control counterclockwise to switch the transceiver OFF.

ADJUSTING THE VOLUME

Rotate the Power switch/ Volume control to adjust the volume. Clockwise increases the volume and counterclockwise decreases it.

SELECTING A ZONE AND CHANNEL

Select the desired zone using the selector if it has been programmed with Zone Select or the keys programmed with Zone Up and Zone Down. Each zone contains a group of channels.

Select the desired channel using the selector if it has been programmed with Channel Select or the keys programmed with Channel Up and Channel Down. Each channel is programmed with specific settings to allow you to send and receive calls.

MAKING A CALL

1 Select the desired zone and channel using the selector and the Zone or Channel keys.

2 Press the key programmed as Monitor to check whether or not the channel is free.

If the channel is busy, wait until it becomes free.

3 Press the PTT switch and speak into the microphone. Release the PTT switch to receive.

For best sound quality at the receiving station, hold the microphone approximately 1.5 inches (3 ~ 4 cm) from your mouth.

4 Release the PTT switch to receive.

BACKGROUND OPERATIONS

Your dealer can activate a variety of transceiver functions to perform without any additional operation on your part.

TIME-OUT TIMER (TOT)

The Time-out Timer is used to prevent any caller from using a channel for an extended period of time. If you continuously transmit for a period of time that exceeds the programmed time, the transceiver will stop transmitting and an alert tone will sound. To stop the tone, release the PTT switch. Your dealer can program the TOT time in the range of 15 seconds to 20 minutes.

If programmed by your dealer, a pre-alert tone will sound before the timer expires. Also, if programmed by your dealer, you may have to wait for a short duration before you can continue to transmit. If you press the PTT switch before the timer has been reset, an alert tone will sound and the transceiver will not enter transmit mode.

RADIO FREQUENCY ENERGY SAFETY INFORMATION

This **KENWOOD** transceiver has been tested and complies with the standards listed below, in regards to Radio Frequency (RF) energy and electromagnetic energy (EME) generated by the transceiver.

- FCC RF exposure limits for *Occupational Use Only*. RF Exposure limits adopted by the FCC are generally based on recommendations from the National Council on Radiation Protection and Measurements, & the American National Standards Institute.
- FCC OET Bulletin 65 Edition 97-01 Supplement C
- American National Standards Institute (C95.1 – 1992)
- American National Standards Institute (C95.3 – 1992)

WARNING

This **KENWOOD** transceiver generates RF EME while transmitting. RF EME (Radio Frequency Electric & Magnetic Energy) has the potential to cause slight thermal, or heating effects to any part of your body less than the recommended distance from this radio transmitter's antenna. RF energy exposure is determined primarily by the distance to and the power of the transmitting device. In general, RF exposure is minimized when the lowest possible power is used or transmission time is kept to the minimum required for consistent communications, and the greatest distance possible from the antenna to the body is maintain. The transceiver has been designed for and is classified for *Occupational Use Only*. Occupational/ controlled exposure limits are applicable to situations in which persons are exposed to RF energy as a consequence of their employment, and such persons have been made aware of the potential for exposure and can exercise control over their exposure. This means you can use the transceiver only if you are aware of the hazards of operating a transceiver and are familiar in ways to minimize these hazards. This transceiver is not intended for use by the general public in uncontrolled environments. Uncontrolled environment exposure limits are applicable to situations in which the general public may be exposed to RF energy, or in which the persons who are exposed as a consequence of their employment may not be fully aware of the potential for exposure or cannot exercise control over their exposure.

The following list provides you with the information required to ensure that you are aware of RF exposure and of how to operate this transceiver so that the FCC RF exposure limitations are not exceeded.

- While transmitting (holding the **PTT** switch), always keep the antenna at least 3 cm (1 3/16 inches) from your body or face, as well as from any bystanders.
- Do not transmit for more than 50% of the total transceiver use time; transmitting over 50% of the total use time may exceed the limits in accordance to the FCC RF exposure requirements. Nominal transceiver operation is 5% transmission time, 5% reception time, and 90% stand-by time.
- Use only the specified antenna for this transceiver; this may be either the antenna provided with the transceiver or another antenna authorized by **KENWOOD**.

Use only **KENWOOD** authorized accessories (antennas, battery packs, belt clips, Speaker/ Mics or headsets etc.): When worn on the body, always place the radio in a **KENWOOD** recommended clip or carrying case meant for this product. The use of other than recommended or approved body- worn accessories may result in RF exposure levels which exceed the FCC's occupational/ controlled environment RF exposure limits.

CAUTION

To ensure that your exposure to RF EME is within the FCC limits for occupational use, you must observe and adhere to the above points.

Electromagnetic Interference Compatibility

Electronic devices are susceptible to electromagnetic interference (EMI) if they are not adequately shielded or designed for electromagnetic compatibility. Because this transceiver generates RF energy, it can cause interference to such equipment.

- Turn OFF your transceiver where signs are posted to do so. Hospitals and health care facilities use equipment that is sensitive to electromagnetic radiation.
- Turn OFF your transceiver while on board an aircraft when so instructed. Use of the transceiver must be in accordance with airline regulations and/or crew instructions.